



US006166772A

# United States Patent [19]

[11] Patent Number: **6,166,772**

Voltz et al.

[45] Date of Patent: **Dec. 26, 2000**

[54] **METHOD AND APPARATUS FOR DISPLAY OF INTERLACED IMAGES ON NON-INTERLACED DISPLAY**

[75] Inventors: **Christopher Voltz; Drew S. Johnson,** both of Houston, Tex.

[73] Assignee: **Compaq Computer Corporation,** Houston, Tex.

[21] Appl. No.: **08/827,977**

[22] Filed: **Apr. 1, 1997**

[51] Int. Cl.<sup>7</sup> ..... **H04N 7/01**

[52] U.S. Cl. .... **348/448; 348/441; 348/443; 348/445; 348/552**

[58] **Field of Search** ..... 348/441, 443, 348/445, 446, 447, 448, 456, 458, 459, 552, 13; H04N 7/01, 11/20

[56] **References Cited**

**U.S. PATENT DOCUMENTS**

4,573,080	2/1986	Maze .....	348/448
4,593,315	6/1986	Willis et al. ....	348/448
4,677,482	6/1987	Lewis, Jr. ....	348/448
4,866,520	9/1989	Nomura et al. ....	348/441
5,475,437	12/1995	Song .....	348/448
5,488,421	1/1996	Hwang et al. ....	348/448
5,594,467	1/1997	Marlton et al. ....	345/115
5,602,654	2/1997	Patti et al. ....	358/461
5,621,470	4/1997	Sid-Ahmed .....	348/448
5,633,687	5/1997	Bhayani et al. ....	348/441
5,661,525	8/1997	Kovacevic et al. ....	348/452
5,675,390	10/1997	Schindler et al. ....	345/327
5,689,305	11/1997	Ng et al. ....	348/416
5,739,867	4/1998	Eglit .....	348/581
5,742,348	4/1998	Kuwahara et al. ....	348/441
5,781,241	7/1998	Donovan .....	348/441

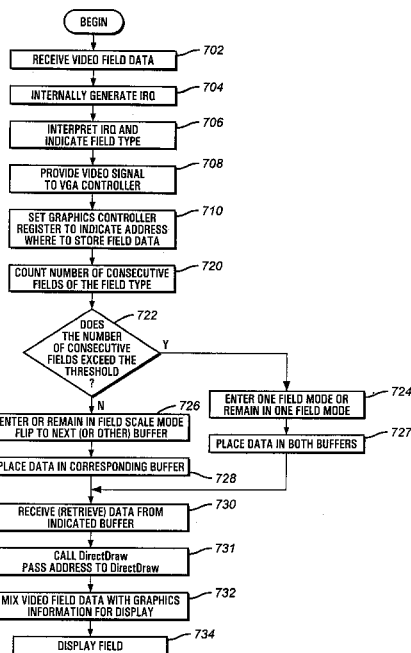
5,784,115	7/1998	Bozdagi .....	348/452
5,787,259	7/1998	Haroun et al. ....	395/200.83
5,790,201	8/1998	Antos .....	348/552
5,793,435	8/1998	Ward et al. ....	348/448
5,796,437	8/1998	Muraji et al. ....	348/452
5,819,156	10/1998	Belmont .....	348/552
5,847,691	12/1998	Mistrot .....	348/552
5,864,369	1/1999	Swan .....	348/448
5,883,670	3/1999	Sporer et al. ....	348/384

*Primary Examiner*—John K. Peng  
*Assistant Examiner*—Jean W. Désir  
*Attorney, Agent, or Firm*—Akin, Gump, Strauss, Hauer & Feld, LLP

[57] **ABSTRACT**

A home entertainment appliance includes a computer system and a television system. A video monitor or television monitor of the home entertainment system shows a sequence of video frames generated in the appliance based upon at least one received sequence of interlaced video fields each containing a number of scan lines. A video system of the appliance receives a first field, temporarily stores the first field in an input buffer, and then in a loop, while video fields are being received, performs various other steps. The other steps include receiving a next field, compensating the field in the input buffer, deinterlacing the received field with the compensated field in the input buffer, temporarily storing the received field, merging the received field and the compensated field into a video frame of the second sequence, and providing the video frame of the second sequence to a subsequent device. Compensating, when performed, may be accomplished by shifting the position of one of the fields downward with respect to the field as it is received, or may be accomplished by delaying the field until the next field is received.

**38 Claims, 11 Drawing Sheets**



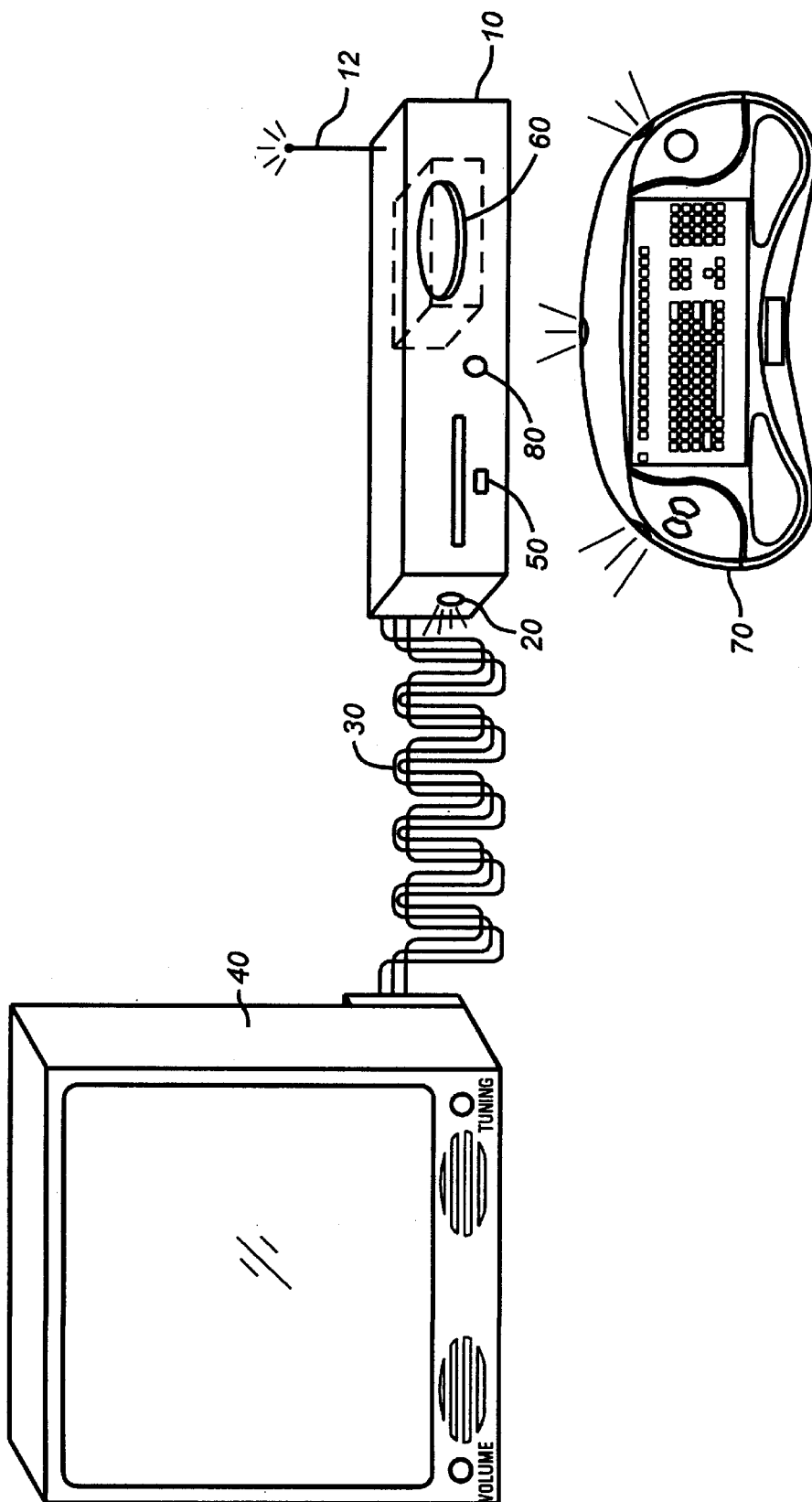
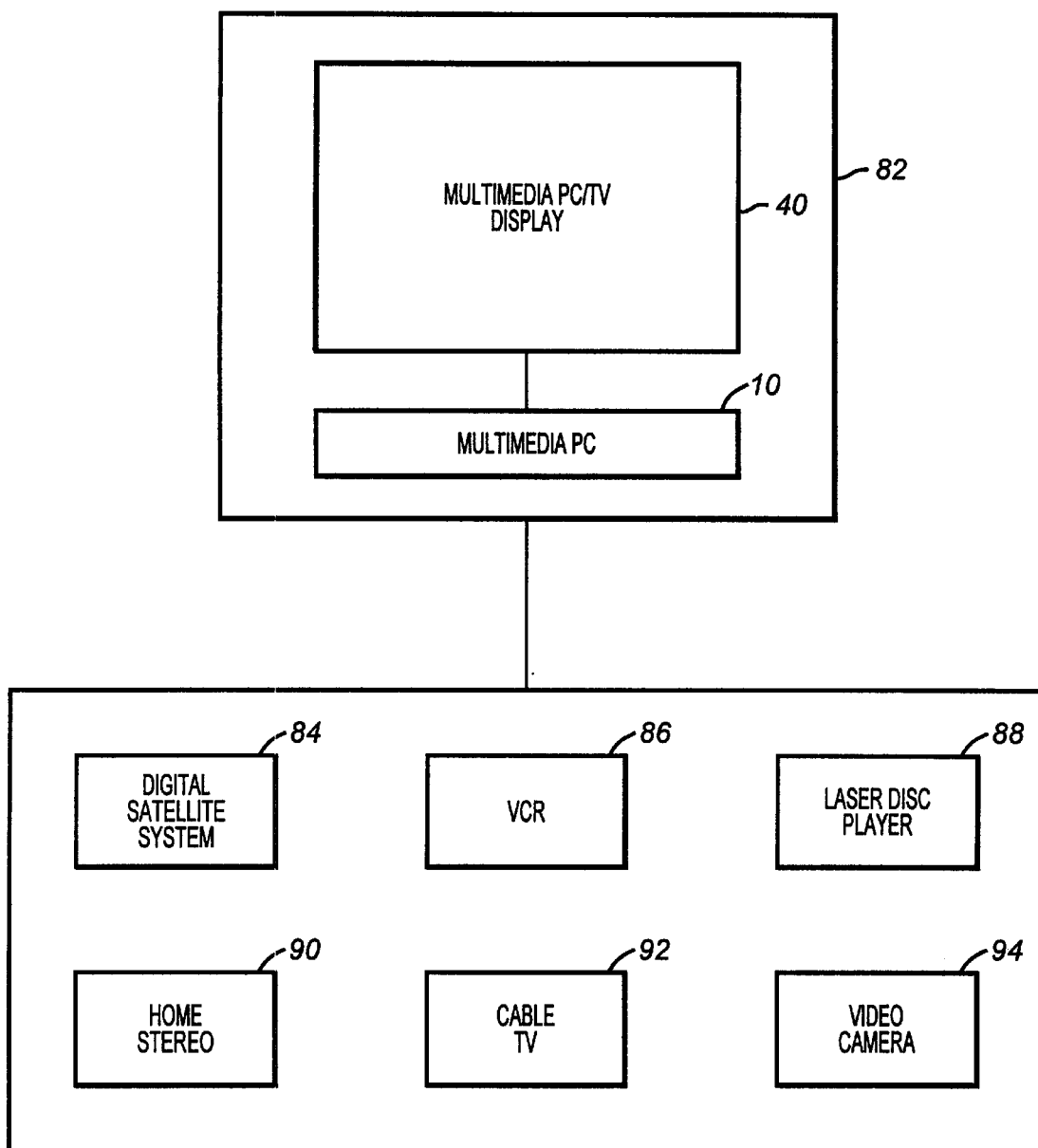


FIG. 1A



**FIG. 1B**

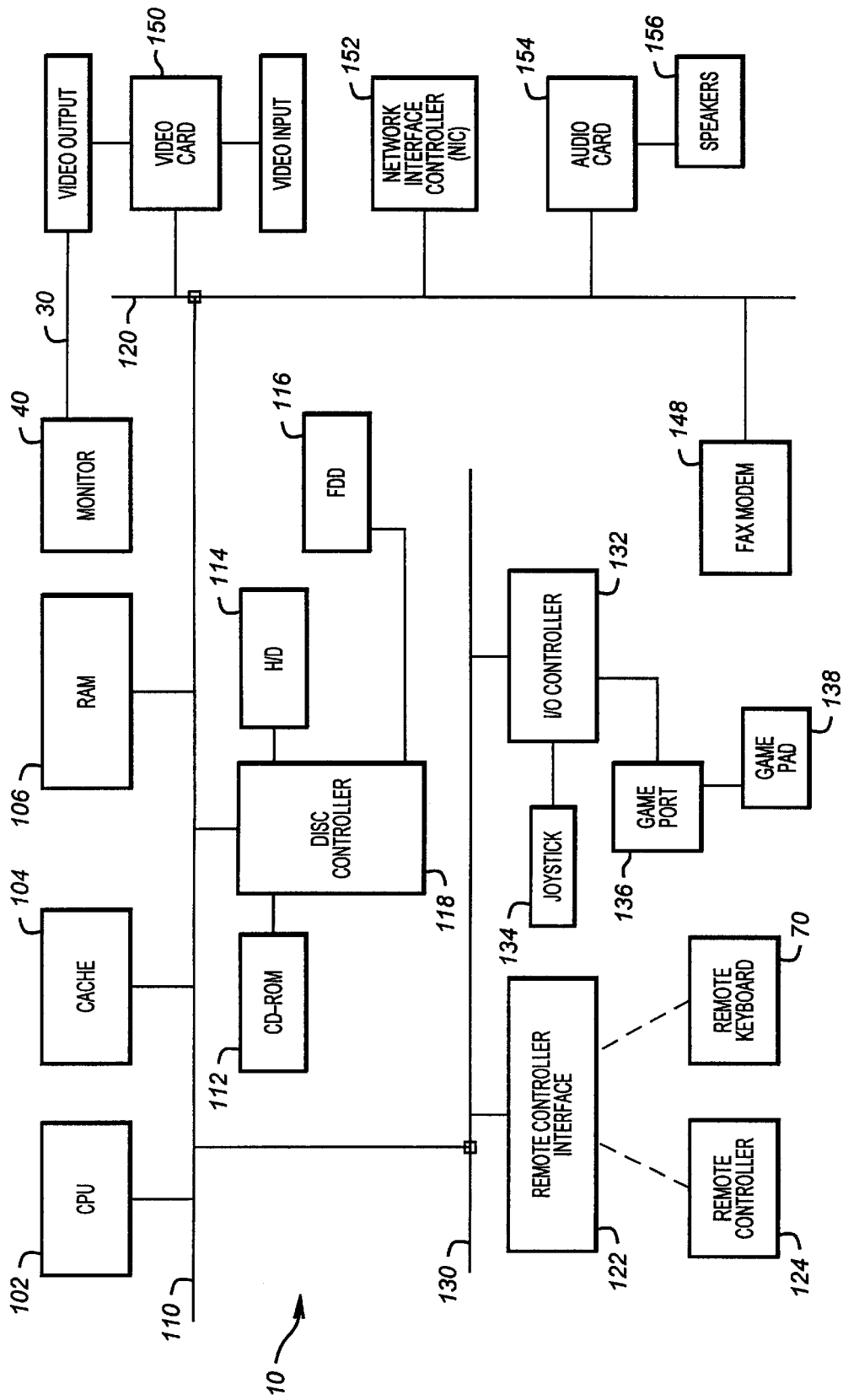


FIG. 2

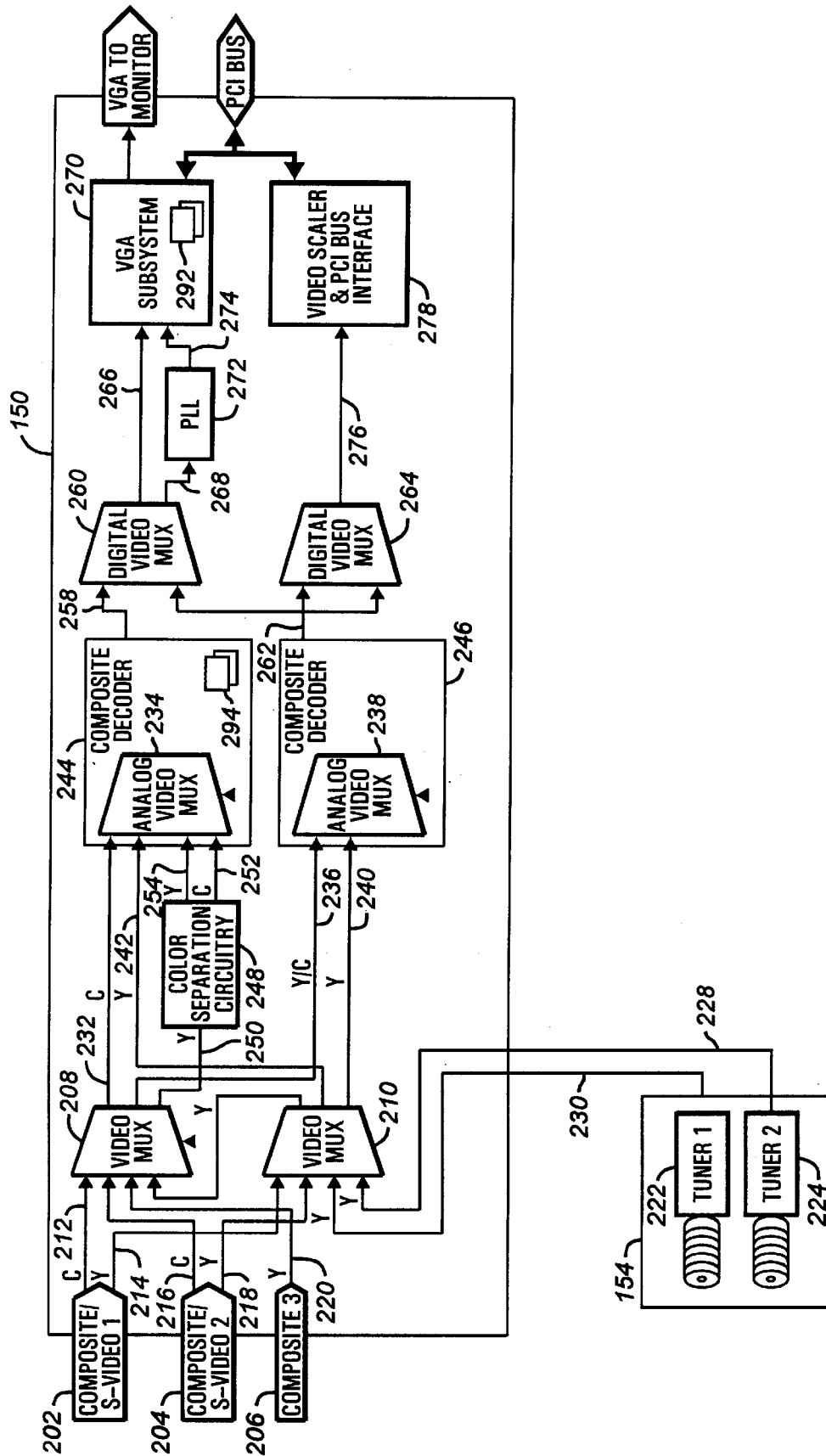
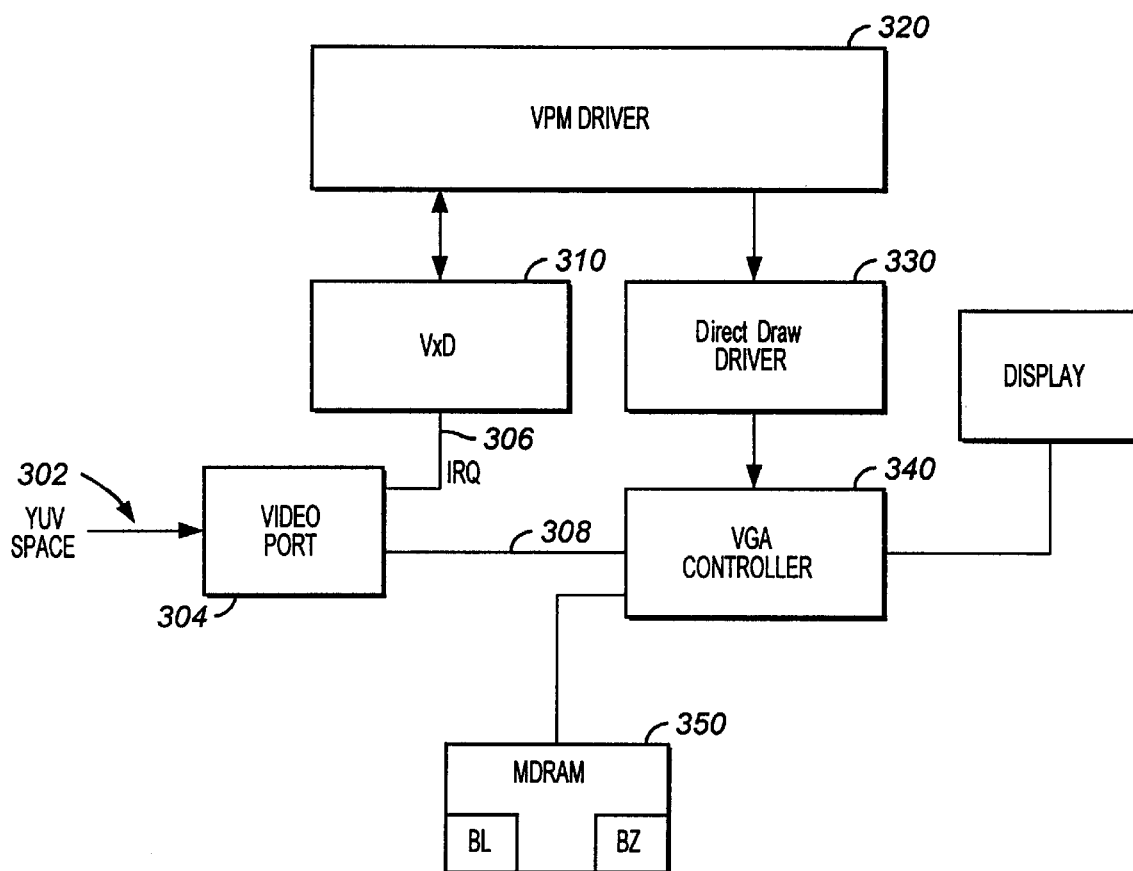
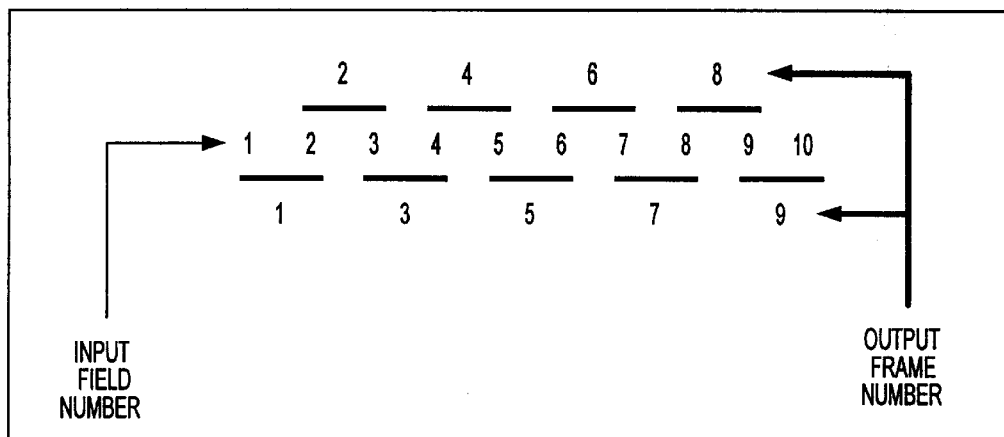


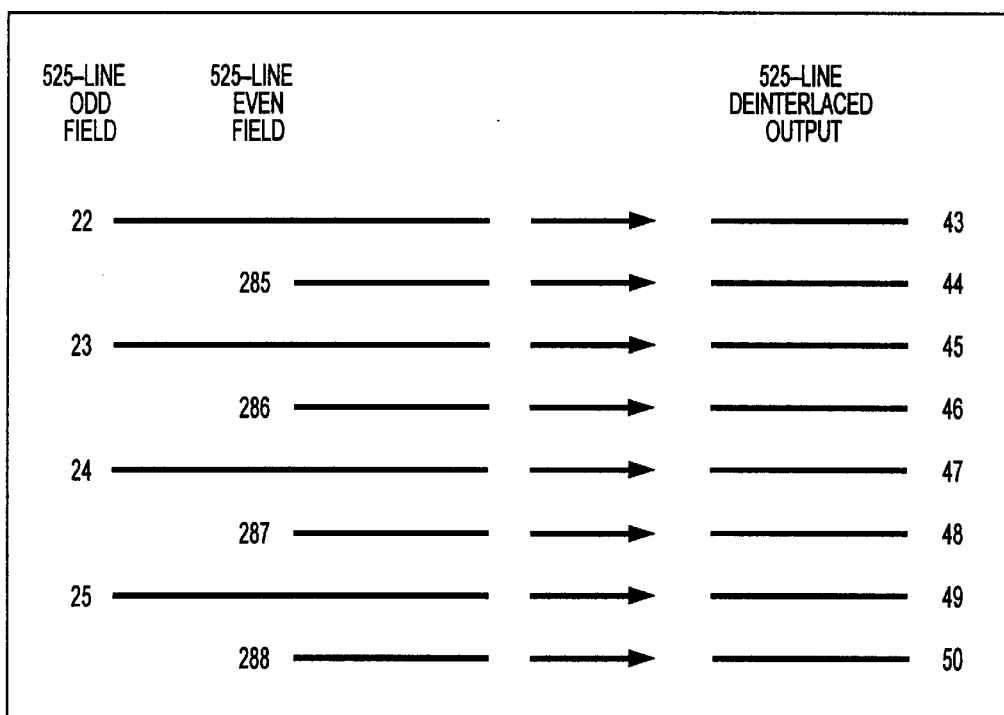
FIG. 3



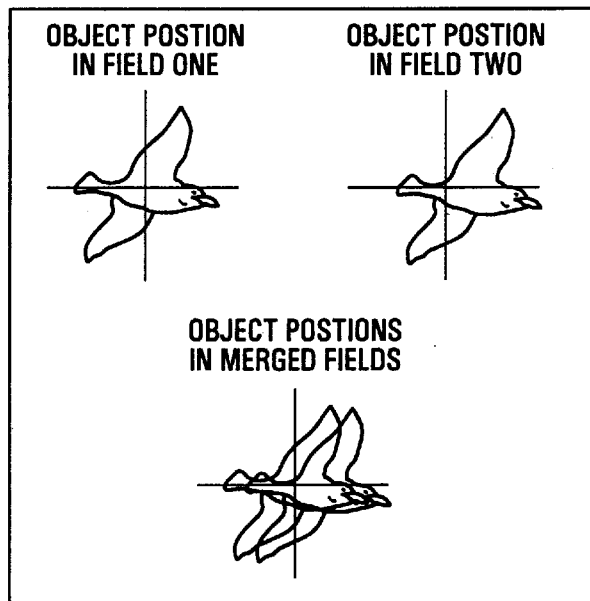
**FIG. 3A**



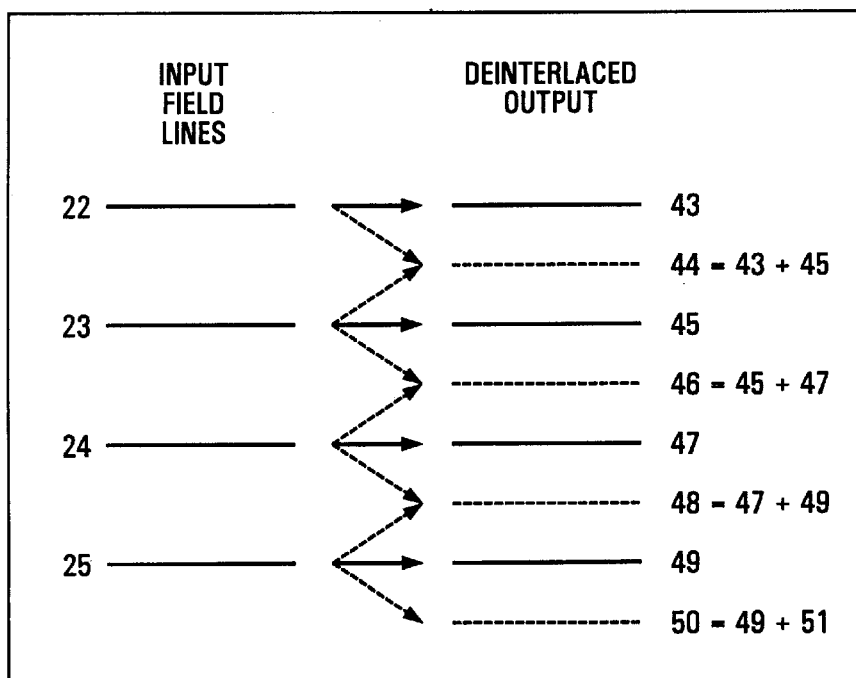
**FIG. 4A**



**FIG. 4B**



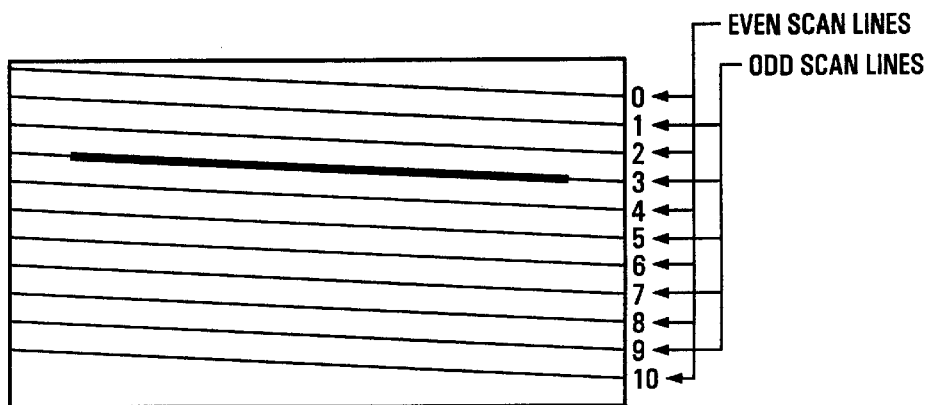
**FIG. 4C**



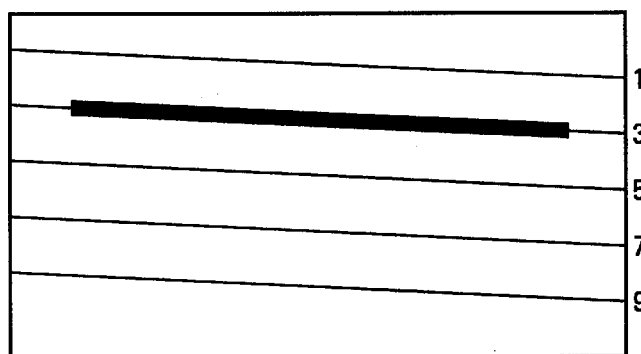
**FIG. 4D**



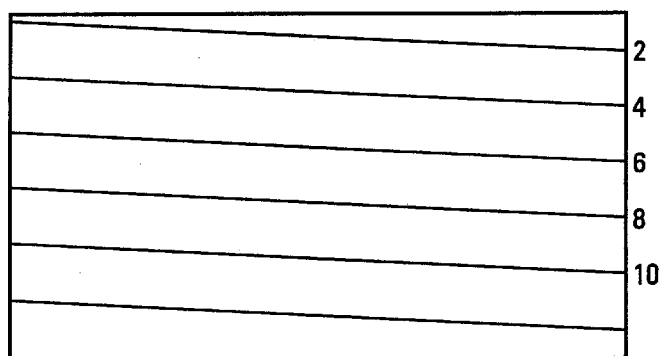
**FIG. 5A**



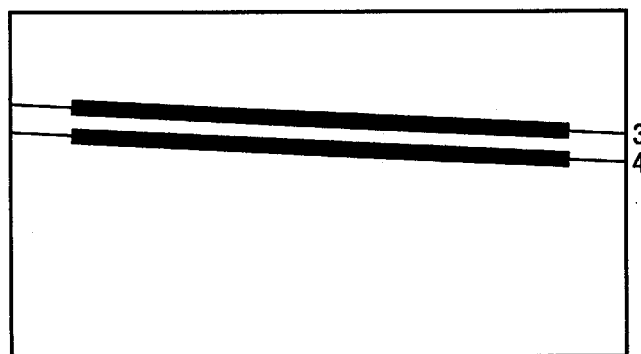
**FIG. 5B**

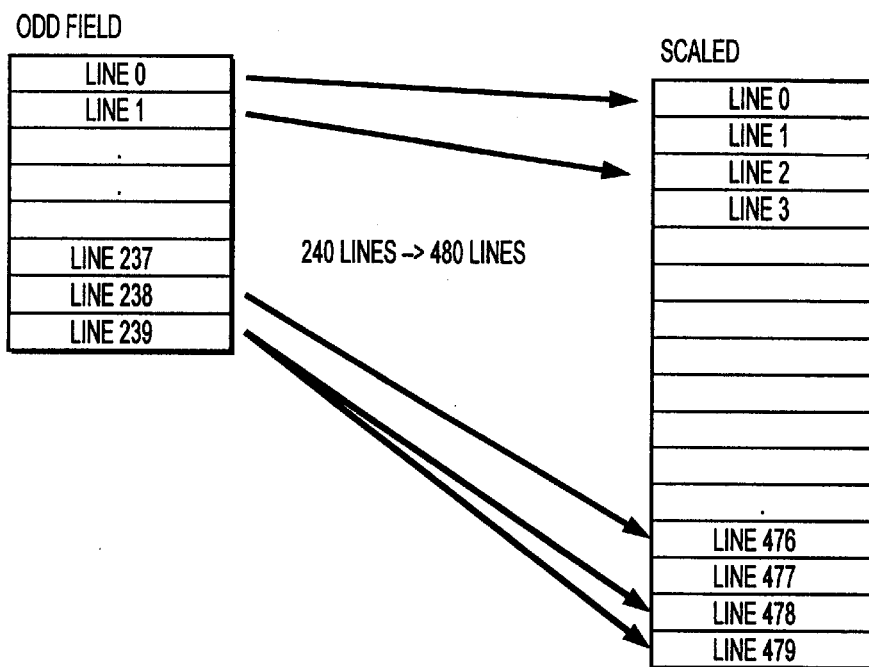


**FIG. 5C**

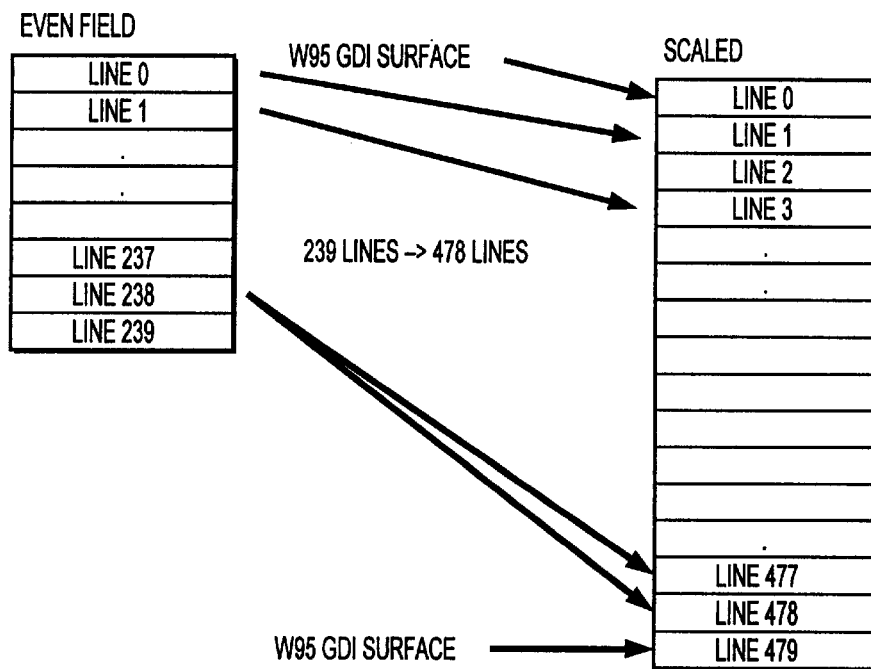


**FIG. 5D**

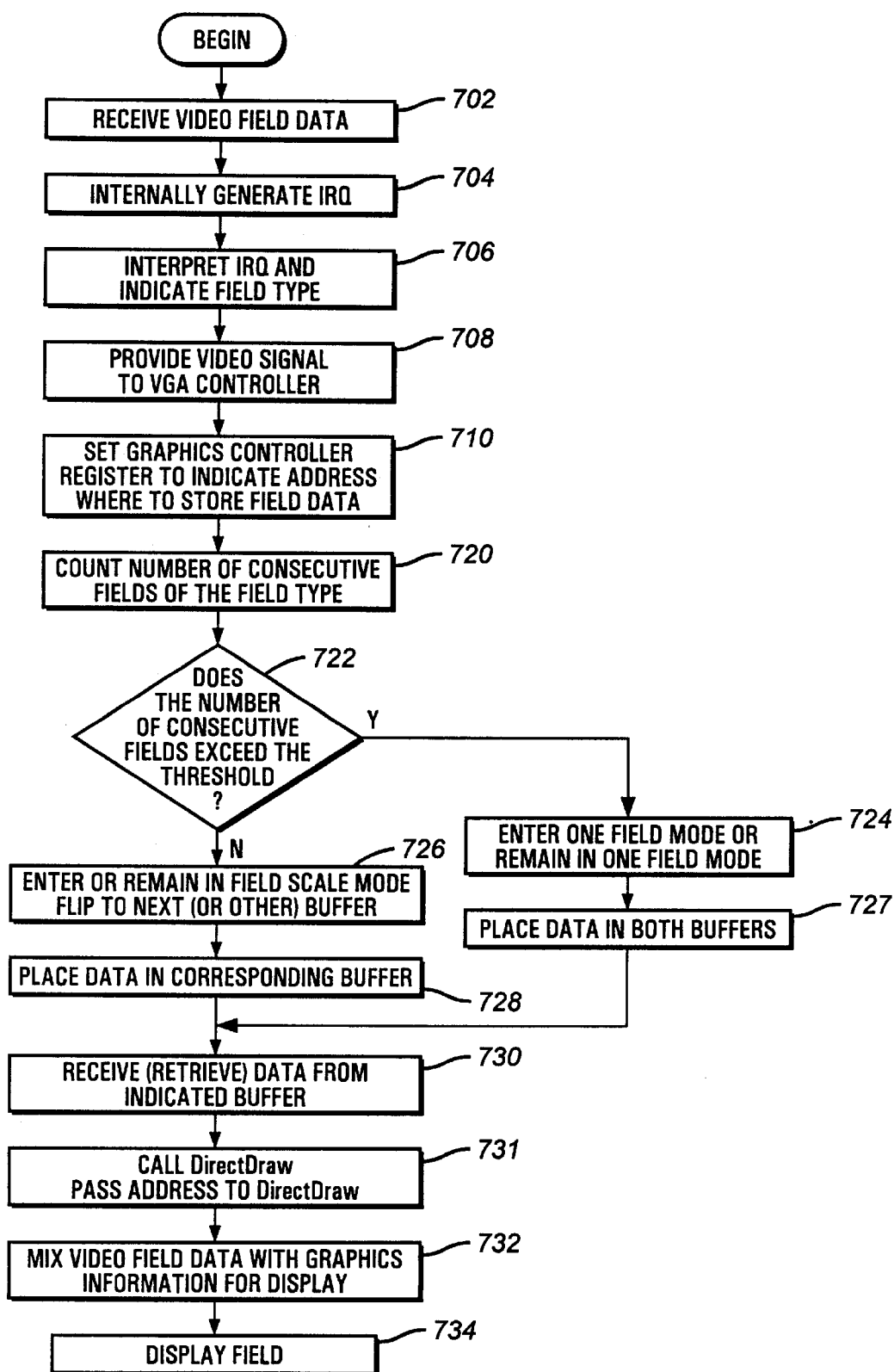




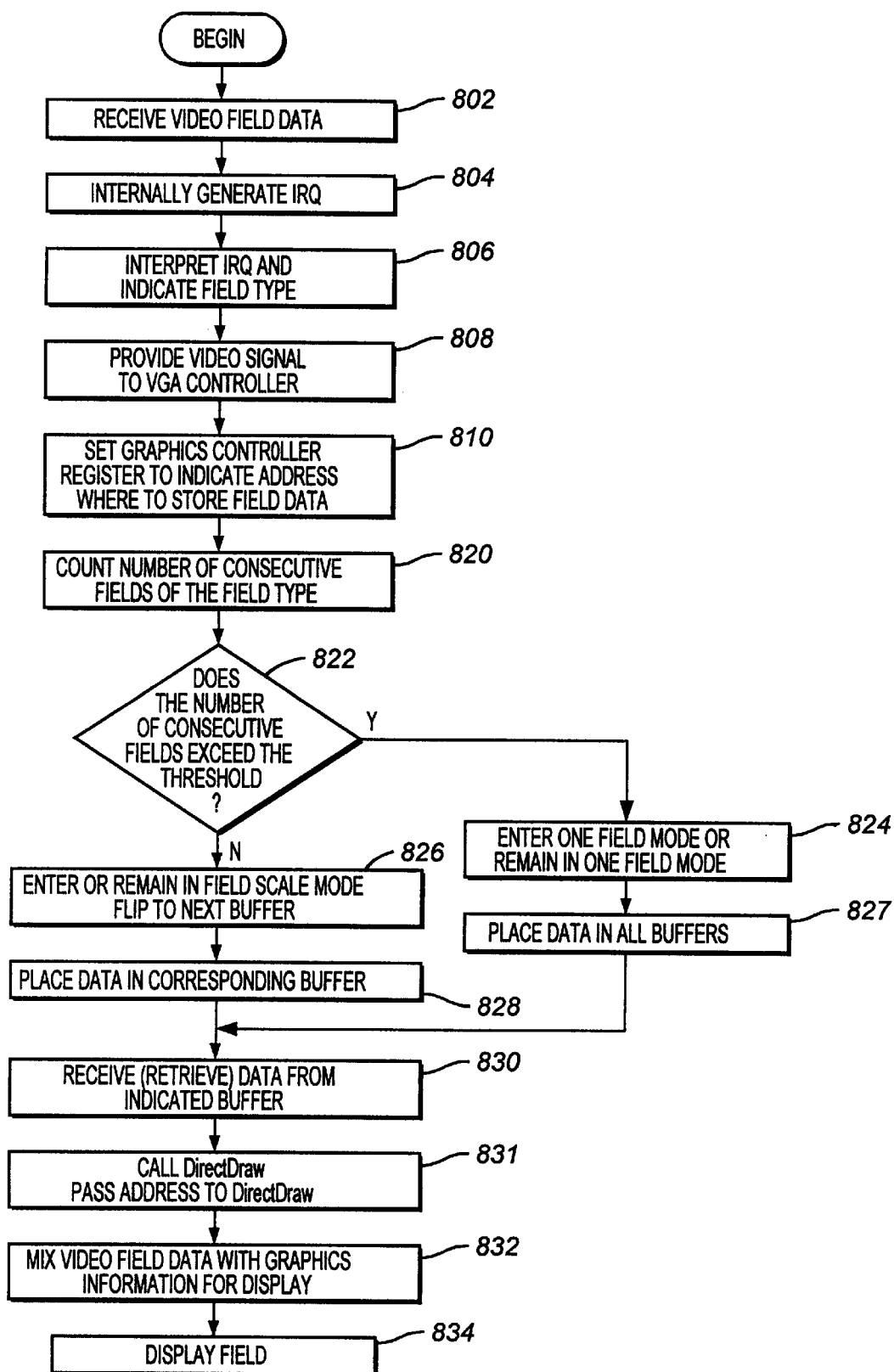
**FIG. 6A**



**FIG. 6B**



**FIG. 7**



**FIG. 8**

## METHOD AND APPARATUS FOR DISPLAY OF INTERLACED IMAGES ON NON- INTERLACED DISPLAY

### TECHNICAL FIELD OF THE INVENTION

The present invention relates to video processing systems, and more particularly to providing an improved video signal in a video processing system in response to a sequence of video fields.

### BACKGROUND OF THE INVENTION

The home entertainment industry is one of the fastest growing areas of the world economy. Direct Satellite Service television, the explosive growth of cable television channels, video on demand, and a host of other services have changed the ordinary television set into a home entertainment center, opening the door to an enormous amount of variety and options. Furthermore, the Internet, the World Wide Web, and the incredible assortment of on-line services, have likewise immersed the home computer in a sea of information. Combining the two—the television as a center for viewing video with the data storage and on-line capabilities of the home computer—is a challenging task that is not without difficulties. The independent developments of these areas of technology have produced sometimes conflicting standards, a natural consequence of the divergent origin of computer and entertainment media.

Television monitors typically present video images in the form of a rapid sequence of video fields, changed at a high frequency to create the illusion of motion. Television cameras and other sources of video generally do not produce full-frame images; rather, such video sources typically produce a field consisting of about half of the lines of each full-frame image, at a rate of 60 such fields per second. Alternate fields contain alternate lines of video data. In other words, one field contains the odd-numbered lines, and the next field contains the even-numbered lines. Accordingly, each field of the video may be identified as an “odd” field or an “even” field. The sequence of video fields alternates between the odd fields and the even fields. A television monitor receiving the sequence of fields then reproduces each video field in the sequence. Each field is displayed on the television screen only on half of the scan lines; first an odd field is displayed, using the odd-numbered scan lines, then an even-field is displayed using the even-numbered field lines, etc. The television scans a raster across the screen from the top left to the top right, producing a first scan line (“scan line #1”), then invisibly returning the raster to the left edge of the screen to a position slightly below the original position. The position to which the raster returns, however, is not immediately below the first scan line, but allows sufficient space to accommodate an intervening scan line on the alternate field. The raster then scans across to the right edge of the screen to produce a second scan line (“scan line #3”), and thus continuing to the bottom edge of the screen. The distance between the scan lines is a function of the size of the window, but generally allows an intervening scan line (the first scan line of the other field, i.e. “scan line #2”) to be drawn after the completion of the first field. The invisible return of the raster to the left edge of the screen after scanning each scan line is a flyback or horizontal refresh stage that occurs much more rapidly than the visible left-to-right lines. In this manner, approximately 485 active scan lines may be produced to complete a single video frame, half of which is displayed in each field. Once reaching the bottom edge of the screen, the raster is then invisibly

returned to the original position at the top left corner during a “vertical blanking interval” stage. The horizontal and vertical blanking interval stages are high speed and invisible. Sixty fields per second may be produced. With respect to typical television, this “interlaced” video scanning approach is an appropriate compromise between vertical refresh rate, vertical resolution, and limited bandwidth.

Although alternating between an odd frame and an even frame may be appropriate for lower -resolution real time video images, computer displays generally must use a progressive video system in which each full frame is presented in sequence, in order to reproduce precise higher resolution graphics information. Displaying computer information in an interlaced manner, in order to mix it with video, would present several unacceptable artifacts. For example, when a narrow horizontal line or edge is a significant part of the image, the line may appear in only one of the two fields. If the narrow horizontal line happens to fall in the odd field, that is, on a scan line having an odd number, then the line only appears when the odd field is being presented. Likewise, a horizontal line in the even field would only be presented when the even field is being presented. Because the odd and even fields alternate, the line or edge thus appears to blink or flicker at a rate of 30 times per second, which is noticeable to most people. This effect is illustrated in FIGS. 5A–5C, discussed below. A similar problem occurs when a horizontal lines is two pixels in width. If a horizontal line is two pixels in width, a single line will appear in each of the odd and even fields. Because these fields are presented alternately, the horizontal line will appear to move slightly in the vertical direction, apparently bouncing or wavering. A two-pixel wide line is shown in FIG. 5D. Not only are these artifacts of flicker and waver distracting in computer graphics, where precise location of lines and edges is crucial, but are exacerbated in a large-screen display, in which each scan line or pixel of the video image is translated to a large region of color or of gray scale on the large screen, making waver even more noticeable.

This leaves the approach of trying to display the interlaced video in a progressive manner, in order to mix the two sources. One approach for this is the “static mesh” approach, in which two successive fields of video are combined and displayed simultaneously. Referring to FIGS. 4A and 4B, the static mesh approach is shown, illustrating deinterlacing of the odd and even fields when both fields contain data. The scan lines in the odd field are mapped to odd lines on the display, and the scan lines in the even field are mapped to the even lines on the display. While this static mesh approach works ideally for stationary images, distracting artifacts are created when the image is moving, since the odd and even fields are received at different times and describe the image (as seen at the video source) at slightly different moments in time. Typically, the temporal displacement between successive fields is  $\frac{1}{60}$ th of a second. When an image moves, successive video fields present the image in a slightly different position. If the object moves slowly, and the odd field and the even field are shown together in the same frame, any edge becomes blurred or shadowed, as the two images appear close to one another. Another problem caused by the motion of the object is double-vision or ghosting, seen when the object is moving more quickly. One effect of the motion of the image is shown in FIG. 4C. Two images may be presented, as the odd lines of the image show one field and the even lines of the image show a different field. Because the even and odd fields are from different times, combining the two images in the “static mesh” can produce a “tearing” or “feathering” around the edges of moving

items. This effect is highly noticeable to many users. Although the static mesh approach is highly appropriate to still images, this tearing or feathering approach is noticeable when an image is moving.

#### SUMMARY OF THE INVENTION

Briefly, the present invention provides an apparatus and method for displaying interlaced images in a progressive manner. It eliminates motion artifacts that would be present in an approach that combines the fields, while minimizing other artifacts.

Additionally, the present invention includes a methodology that allows scaling of a video image to any window size, and for mixing with noninterlaced images. The present invention also provides detection and adjustment for the case where the input video is from a single field, e.g. a video game device.

#### BRIEF DESCRIPTION OF THE DRAWINGS

FIG. 1A shows a home theater computer system.

FIG. 1B shows a block diagram of the home theater system of the present invention.

FIG. 2 shows a simplified block diagram of a computer system C is shown including a video card 150.

FIG. 3 shows a schematic diagram of the video card 150 of the home theater system of the present invention.

FIG. 3A shows the VGA subsystem in greater detail is shown.

FIGS. 4A and 4B show deinterlacing of consecutive odd and even input fields according to the static mesh approach when both fields contain data.

FIG. 4C shows one effect of the motion of the image in the static mesh mode.

FIG. 4D shows the field scaling approach to deinterlacing when only one field contains data.

FIG. 5A shows a simplified video scan pattern according to the prior art, comprising a simplified 11-scan line full-frame video image having a narrow horizontal line drawn on the scan line number 3.

FIG. 5B shows the horizontal line in one of the fields.

FIG. 5C shows the other field in which the horizontal line is absent, since the line is not wide enough to exist on more than one scan line.

FIG. 5D shows a full-frame image having a narrow horizontal line that is present on two full-frame scan lines.

FIGS. 6A and 6B show the FieldScale approach as performed in the VPM Driver according to instructions from the DirectDraw Driver.

FIG. 7 shows one method according to the present invention.

FIG. 8 shows a second method of the present invention.

#### DETAILED DESCRIPTION OF INVENTION

Referring now to FIG. 5A, a simplified video scan pattern according to the prior art is shown. Commonly, video signals are presented to a monitor or multimedia display by tracing scan lines across the monitor horizontally. At the end of each scan line, a raster provides a flyback or horizontal refresh to the beginning of the next scan line. At the end of the image, typically at the bottom of the screen, a vertical blanking interval or vertical refresh restores the raster to the top of the screen. In many systems, 485 active scan lines are provided. Due to the time required to trace out 485 active scan lines,

however, and because the human eye is generally incapable of distinguishing a particular scan line from the scan line immediately above or below it, many systems use an alternating approach to presenting video information. Initially, the video monitor scans horizontally, but presents only the even numbered lines to the screen. In other words, the horizontal information is presented only on alternating lines. At the bottom of the screen, the vertical blanking interval (vertical refresh) restores the raster to the top of the screen, and the odd numbered lines are then presented. At the bottom of the screen, after the odd lines have been presented, the vertical blanking interval restores the raster to the top of the screen, and the cycle is repeated, with the even numbered lines next being presented. The vertical blanking interval (VBI) is in addition to the active scan lines, bringing the total to 525 scan lines, of which 485 are active and the remainder are associated with the VBI. FIG. 5A illustrates this approach, depicting a simplified 11-scan line display having a horizontal line drawn on the scan line number 3. In FIG. 5A, a narrow horizontal line is present in a full-frame video image. The horizontal line may be an edge of an object within the video frame, or may be a very narrow object such as a border or line in the image. FIG. 5B shows the horizontal line in one of the fields. The line is included, because it occurs on one of the scan lines that forms the relevant field. However, FIG. 5C shows the other field. In FIG. 5C, the horizontal line is absent, since the line is not wide enough to exist on more than one scan line. As described, the fields of FIG. 5B and FIG. 5C alternate in normal video. Thus, in normal video or other situations in which the two fields are alternately presented, the line will be present when one field is being displayed and absent when the other field is being displayed. The line will appear to flicker, at a frequency of about  $\frac{1}{30}$ th of a second.

Referring now to FIG. 5D, a full-frame image having a narrow horizontal line that is present on two full-frame scan lines is shown. As can be expected, when an odd field and an even field are formed from the video frame of FIG. 5D, each field will have a single horizontal line one pixel wide. As the fields alternate, the line will appear to bounce up and down, since the two fields display their lines at slightly different positions on the display screen.

Referring now to FIGS. 4A and 4B, deinterlacing of consecutive input fields is shown in greater detail. For example, the deinterlacing of the first and second input fields to produce the output frame number 1 is illustrated. A first field that is either the odd or even field consists of either 262 or 263 lines of video data. Similarly, a second input field that is either the even or odd input field, consists of either 262 or 263 scan lines of video data. Specifically, for example, the first field may be input field #1 and the second field may be input field #2, as shown in FIG. 4A. Alternating lines of the two fields are deinterlaced or enmeshed together, producing a 525 line deinterlaced output, as shown in FIG. 4B. As shown in FIG. 4A, input fields #1 and #2 are deinterlaced to produce output frame #1. FIG. 4B shows the deinterlacing method in greater detail. Line 22, for example, in the odd field (input field #1) is presented as line 43 of the deinterlaced output. Line 23 of the odd field is presented as line 45 of the deinterlaced output. Between the two adjacent lines of the odd field thus presented, line 285 of the even field is presented as line 44 of the deinterlaced output. Consequently, and in this manner, adjacent lines of the deinterlaced output are derived from alternating input fields.

As shown in FIG. 4A, a first input field is received. Immediately thereafter, a second input field is received, and the first and second input fields are deinterlaced together and

presented via the VGA graphics system on the monitor **40** (as frame number **1**). The second input field is temporarily stored in an input buffer, so that the second input field will remain available after the deinterlacing with the first input field. Soon thereafter, a third input field is received. The second input frame, still available from the input buffer, is deinterlaced with the third input field and the deinterlaced frame is presented via the VGA graphic subsystem on the monitor (as frame number **2**). The third input field also replaces the second input field data in the input buffer. Subsequently, a fourth input field is received. The fourth input field is deinterlaced with the third input field data in the input buffer, and the deinterlaced frame presented via the VGA graphics subsystem on the monitor **40** (as output frame number **3**). The fourth input field is also stored in the input buffer, replacing the third input field data in the input buffer. In this manner, thereafter, additional input fields are similarly received, are interlaced with data in the input buffer, the interlace stored alternately in the odd and even buffer, and the new input field replaces the previous data in the input buffer.

Referring now to FIG. **4D**, the field scaling approach to deinterlacing when only one field contains data is shown. As described above, some video sources, such as Nintendo and other video games, provide only one type of field. Typically, such systems provide an even video field but do not provide an odd video field. Many video systems using such input sources have empty black lines between the active lines. Therefore, in some embodiments, the present invention includes a detector that determines whether fields of only one type are being presented. As stated previously, the entire full frame of a video image comprises 485 active scan lines and a vertical blanking interval of a duration corresponding to 40 additional (invisible) scan lines, for a total of 525 scan lines. Each field therefore contains half that number, i.e. 262 or 263 scan lines of which approximately 240 contain data. The sequence of input fields is not deinterlaced as shown in FIGS. **4A** and **4B**, but rather according to a method illustrated in FIG. **5B**. The difference between the method shown in FIGS. **4A** and **4B** and the method shown in FIG. **5B** is explained by the absence of odd numbered input fields, or even numbered input fields, in the latter. When only one input buffer is used, the graphics system must generate the missing scan lines. One method for deinterlacing a single input field is shown in FIG. **5B**. Line **22** of the single field provides line **43** of the deinterlacing output, similarly to the method shown in FIG. **4B**. Also, line **23** of the input field provides line **45** of the deinterlaced output. However, in the absence of an even field, line **44** is calculated through an interpolation of the adjacent lines that are present. As shown in FIG. **4B**, line **44** of the deinterlaced output is derived from an averaging of line **43** and **45** of the deinterlaced output.

Turning now to FIG. **1A**, a home theater computer system is shown. The home theater computer system of FIG. **1A** provides computing capability as well as audiovisual theatrical projection capabilities. The home theater computer system of FIG. **1** revolves around a computer base unit **10** which is multimedia-capable. Multimedia refers to the integration of text, audio, graphics, still image, and moving pictures into a single computer-controlled product. It includes the combination of computers, video or compact disc players, video monitors, optical scanners, audio cards, music synthesizers, etc., all linked together by system software.

In the home theater computer system of FIG. **1A**, the normal computer display which is optimized for viewing at 15–18 inches from the user's eyes is replaced with a high

resolution display unit **40**, which is preferably a VGA compatible display with resolutions of 720×480 pixels. The display unit **40** is driven by the computer base unit **10** via a cable **30**. The display unit **40** is capable of acting as either a computer monitor in one mode of the system or as a television unit in a second mode. When receiving TV transmission, the computer base unit **10** has a tuner **12** for receiving TV signals over the air waves.

The computer base unit **10** of FIG. **1A** also contains a compact disk read only memory (CD-ROM) drive **60**, a floppy drive **50**, and a plurality of communications ports **20** and **80**, preferably radio-frequency or infrared data ports. The communication ports **20** and **80** communicate with a keyboard **70**. In addition, the computer housing **10** has an tuner **12** for receiving television transmissions. With respect to the keyboard **70**, the keyboard transmits serial information over one or more infrared connections thereby achieving wireless portability.

Turning to FIG. **1B**, a block diagram of the home theater system of the present invention is shown. The PC theater **82** of the home theater system includes a multimedia PC/TV display **40** and a multimedia PC **10**. The multimedia big screen display or monitor **40** displays a digitally enhanced picture. The PC theater **82** provides at least a PC mode and a TV mode. In the PC mode, the multimedia PC **10** provides the necessary hardware. The PC theater **82** can be connected to a variety of multimedia equipment, such as a digital satellite system **84**, a VCR **86**, a laser disc player **88**, a home stereo **90**, cable TV **92** or a video camera **94**. In this way, the home theater system provides and integrates various multimedia functions.

Referring now to FIG. **2**, a simplified block diagram of a computer system C is shown including a video card **150**. A central processing unit **102** is coupled to a host bus **110**. The central processing unit **102** may be a single microprocessor, such as an Intel Corporation's 486 or Pentium, or a more complete CPU system including multiple microprocessors, a cache controller, external coprocessors, and other components, coupled to one another or to the host bus **110**. The host bus **110** functions to interface the CPU **102** to the rest of the computer system C. The host bus **110** typically is located on a motherboard, but may be configured as any of a number of other subsystems, as known in the art.

Also coupled to the host bus **110** is a cache **104**. The cache may be a write through, a write back, or multi-level cache system for storing commonly used or recently used data values. The cache generally consists of a high speed static RAM structure, addressable within the memory space of the CPU's address lines.

A main memory, typically comprising a dynamic RAM **106**, is coupled to the host bus **110**. The main memory provides relatively high speed data storage for instructions and data needed for the processor to perform its functions.

Also included in many computer systems is a dedicated ROM (not shown) providing system BIOS and other firmware sets of instructions to the processor, on initial bootup and also thereafter.

Also coupled to the host bus **110** is a disc controller **118**. The disc controller **118** typically has a number of IDE ports to couple external devices. The disc controller **118** may be coupled directly to the CPU or to main memory, or may be a separate device on the host bus **110**. The disc controller **118** provides a connection to a CD ROM **112**, a hard disc **114**, a remote controller interface **122**, and an input/output controller **132**, and a floppy disc drive **116**. The CD ROM **112** provides optical storage and data retrieval capabilities, and

the hard drive **114** and floppy disc drive **116** provide magnetic storage device capabilities to the computer system.

Also coupled to the host bus **110** are two extension buses. The first extension bus is a PCI bus **120**, coupled to the host bus **110** via a PCI bridge. The PCI bus **120** is coupled to a plurality of additional devices, including the aforementioned video card **150**, a network interface controller **152**, an audio device or audio card **154**, a fax modem **148**, and in some embodiments an additional PCI bridge (not shown). The video card **150** typically includes a graphics processor and a video graphics adapter, and is coupled to a monitor **40** via a coaxial cable **30** or other computer connector. The audio device **154** generally is coupled to audio speakers **156** or other audio output device to provide an audio output.

A second extension bus **130** is coupled to the host bus **110**, providing an extension for additional peripheral components. Although typically configured as an X-bus or be an ISA bus, the extension bus **130** may alternately be configured as an EISA, a PCI bus, a microchannel bus, or any of a variety of other bus structures commonly used and known.

The remote controller interface **122**, coupled to the second extension bus **130**, provides infrared signal detection, and is optically and remotely coupled to a remote keyboard **70** and a remote controller **124**. The remote keyboard **70** and remote controller **124** allow a human user or an external device to communicate data via the remote controller interface **122** to the computer system C, without direct wired connection.

The input/output controller **132**, also coupled to the second extension bus **130**, provides connection between the extension bus **130** and various devices, including a game port **136** coupled to a game pad **138** and to a joy stick **134**. Although these devices are shown coupled through the input/output controller **132** to the extension bus **130**, it will be recognized that other configurations are possible; for example, the joy stick **134** may instead be coupled to an infrared device for communicating directly to the remote controller interface **122**.

It will be recognized that additional devices may be coupled via IDE controllers and other connectors to the various buses, providing resources and buffering for external devices. The flexibility of the computer system therefore is not restricted to the particular example shown in the figure. In many computer systems, the hardware configures itself according to the instructions in the BIOS upon power up.

Turning to FIG. 3, a schematic diagram of the video card **150** of the home theater system of the present invention is shown. The inputs to the video card **150** include three composite video signals provided through Y/C video connectors, composite\_1 **202**, composite\_2 **204**, and composite\_3 **206**. The constituent signals of the three input composite signals are provided to a pair of video multiplexers **208** and **210**. The chrominance signal **212** from the composite\_1 signal **202** is provided to video multiplexer **210**, and the luminance signal **214** of the composite\_1 signal **202** is provided to video multiplexer **210**. The chrominance signal **216** of the composite\_2 signal **204** is provided to video multiplexer **208**, and the luminance signal **218** of the composite\_2 signal is provided to video multiplexer **210**. The composite\_3 signal **206** includes a luminance signal **220** which is provided to video multiplexer **208**. Tuners **222** and **224** located on the audio card **154** of the computer system **10** also provide input luminance signals **228** and **230** to video multiplexer **210**. Other devices that are provided on the audio card **154** are not shown as the audio card **154** is not critical to an understanding of the invention.

A signal **232** outputted from video multiplexer **208** is provided to a primary analog video multiplexer **234**. Video multiplexer **208** also provides a Y/C signal **236** to a secondary analog video multiplexer **238**. Video multiplexer **210** provides two signals **240** and **242**; one signal **242** is provided to the primary analog video multiplexer **234**, and the other signal **240** is provided to the secondary analog video multiplexer **238**. The analog video multiplexer **234** is integrated into a primary video composite decoder **244**, and the secondary analog video multiplexer **238** is integrated into a secondary video composite decoder **246**. The primary decoder **244** of the present invention may or may not include color separation circuitry.

The video board **200** of the present invention includes color separation circuitry **248** external to the primary decoder **244**. The color separation circuitry **248** receives a composite signal **250** as an input from video multiplexer **208** and outputs a chrominance signal **252** and a luminance signal **254** to the primary analog video multiplexer **234** of the primary decoder **244**. The color separation circuitry **248** includes a digital comb filter **256**. Within the digital comb filter **256**, video information is converted from analog to digital and back to analog. The decoded video signal **258** outputted by the primary video composite decoder **244** is provided to a digital video multiplexer **260**. Similarly, the output video signal **262** of the secondary video composite decoder **246** is provided to a digital video multiplexer **264**.

The primary digital video multiplexer **260** provides two outputs **266** and **268**. One output **266** is provided directly to the VGA subsystem **270**. The other output **268** is directed to a phase-locked-loop **272** (PLL). The PLL **272** supplies a clock signal **224** to the VGA subsystem **270**. The VGA subsystem **270** has two memory areas; one area is used as an off-screen memory area for storing video information such as font information and data yet to be displayed. The other memory area is used to store data which is currently being displayed. The VGA subsystem **270** also includes a VGA controller. In displaying data, the VGA controller reads from the off-screen memory, scales the data if needed, performs color space conversion, and then sends the data through a digital-to-analog converter (DAC) to the display. In the secondary path, the secondary digital video multiplexer **264** provides a signal **276** to a video scaler and PCI bus interface **278**. When data is sent over the secondary path, the data is downscaled if needed and then burst over the PCI bus **120** into the off-screen memory area of the video memory. The secondary path is typically used for picture-in-picture (PIP) functionality or pulling up web pages contained in the vertical blanking interval while watching television on the display **40** which are encoded in the vertical blanking interval (VBI).

Referring now to FIG. 3A, the VGA subsystem in greater detail is shown. A video source signal **302**, in YUV space, is received at a video port **304** to the VGA subsystem. The video port **304** is preferably a Viper 6100 video port from Tseng Labs. The video port **304** crops the input signal to a field size of 720 pixels by 240 pixels. The video port provides an interrupt IRQ signal **306** and a video signal **308**. The IRQ **306** is interpreted by a VxD **310**, a software component running on the main system processor, to indicate that a video field has been received at the video port. The video port **304** also provides a video signal directly to the VGA Controller **340**. The direct signal from the video port **304** to the VGA Controller **340** includes video data of the active field. The VGA Controller **340** has coupled thereto an MDRAM, for storing the odd field and the even field. The MDRAM **350** includes two regions, or a pair of buffers or



a segmented buffer, each region storing video data pertaining to one or the other video field. At any moment in time, one of the buffers or segments in the MDRAM 350 is a frontbuffer, and the other is a backbuffer. Flipping between the frontbuffer and the backbuffer is performed when a new field is received by the input port 304, at which time the IRQ 306 is generated.

The VxD 310 identifies the arrival or end of a received video field to the VPM driver 320, and sets a register in the graphics controller corresponding to where to store the data corresponding to the video field. The VxD 310 also identifies whether the input video signal 302 received by the video port 304 at that moment is an even field or an odd field and provides the identification to the VPM driver 320. The VPM Driver 320, like the VxD 310, is in software and is running on the main video processor, and can call a DirectDraw Driver 330. The identification as odd or even is performed regardless of the operating mode of the VxD 310; in the FieldScale mode with odd/even source, odd fields are directed to one buffer and even fields are directed to the other, while in the OneField mode either odd or even fields are directed to both buffers. The VxD 310 receives the addresses of the appropriate buffer from the VPM driver 320, which counts the number of consecutive fields of a given type and can command switching from one operating mode to another.

The VPM Driver 320 provides the common interface for control of the video port (via the VxD 310) and DirectDraw overlay surfaces. The VPM Driver 320 calls the DirectDraw Driver 330 in order to indicate which buffer to display, and where it should be displayed.

The DirectDraw Driver 330 is in software and is running on the main video processor. The DirectDraw Driver 330 is responsible for making the graphics controller display the fields in an appropriate manner, and mixing video field data with graphics information for display.

In the FieldScale mode with an odd/even source, received fields are placed alternately in the odd and even buffers. Therefore, all the odd fields are placed in one buffer and all the even fields are placed in the other buffer. The DirectDraw Driver 330 is used to make the graphics controller present data from the two buffers alternately on the display. There is no meshing of the images from one buffer with the images from the other buffer, except in the eye of the person viewing the image. Each field is scaled as described below in reference to FIGS. 6A and 6B.

Because data from one field only is presented at any given moment in time, temporal data from different points in time are not mixed. Each field is received individually, and is displayed individually. As with standard video, motion is achieved in the eye of the viewer. The interpolation of the missing scan lines provided in the FieldScale algorithm of FIGS. 6A and 6B provide almost as good a resolution as would copying the missing scan lines from the alternate field, and eliminates the temporal artifacts of blurring and double imaging caused by mixing temporal data. Also, because the alternate field is flipped onto the field of view only  $\frac{1}{60}$ th of a second later, the human eye provides a mixing of the interpolated scan line with the true data in the alternate field, substantially correcting for any loss of resolution.

In the OneField mode with an even-only or odd-only source, i.e. when the VPM Driver 320 has commanded the VxD 310 to switch to OneField mode, the VxD 310 driver responds by placing either received odd frames in both buffers or received even frames in both buffers. This is

common when the video source is received from a video game, for example. The fields are scaled according to the field scaling described below in reference to FIGS. 6A and 6B, and the resulting graphics signal is provided at the normal frame rate. The VPM Driver 320 passes the addresses of both buffers to the VxD 310, and the VxD 310 stores the data in both buffers accordingly. (In an alternate embodiment, only one buffer (or segment of a buffer) need be used. Each received field is placed simultaneously in both buffers, and the VPM Driver 320 performs flipping normally). The DirectDraw Driver 330 is used to make the graphics controller present data from the two buffers alternately on the display, just as in fieldscale mode. However, in the OneField mode, the two buffers are scaled in the same manner, without displacement. Each field is scaled as described below in reference to FIGS. 6A and 6B.

The VGA Controller 340 is preferably an ET6000, from Tseng Labs. The VGA Controller 340 is further coupled directly to the video display or monitor. The VxD 310, VPM Driver 320, and DirectDraw Driver 330 are all software components, running on the main system processor. The VPM Driver 320 determines whether the video input signal includes a single field source such as from a video game or a compound field source (i.e., an alternating sequences of odd and even fields) such as from a standard video source. The VPM Driver 320 calls the DirectDraw Driver 330 which provides all of the direct manipulation of the overlay surfaces.

Referring now to FIG. 6A, Field Scaling of the odd fields is performed when so indicated by the VPM Driver 320. The odd field 602 contains 240 lines, corresponding to the odd-numbered scan lines in the video frame. Field scaling is initiated by the VPM driver 320, described above with reference to FIG. 3A, when the ratio of the window or display size to the size of the odd field exceeds the predetermined threshold. In the preferred embodiment, field scaling is performed when the ratio exceeds 1.5. As shown in FIG. 6A, line 0 of the odd field is mapped directly to Line 0 of the scaled field. The graphics controller then interpolates Line 1 of the scaled field, based on the values of line 0 and line 1 of the odd field. Then, line 2 of the scaled field is mapped from line 1 of the odd field. In this manner, the larger scaled field is determined from the odd field, without reference to any value of the even field. Only the scan lines of the odd field and the values interpolated therebetween determine the scaled field lines. Generally, all of the odd field lines and none of the even field lines are used, and are mapped directly to particular lines of the scaled field, and additional scaled lines are thus determined by interpolation. Although not shown, horizontal enlargement or shrinking of the image may be accomplished simultaneously.

Referring now to FIG. 6B, Field Scaling of the even fields is performed when so indicated by the VPM Driver 320. The even field 602 also contains 240 lines, corresponding to the even-numbered scan lines in the video frame. Field scaling is initiated by the VPM driver 320, described above with reference to FIG. 3A, when the ratio of the window or display size to the size of the odd field exceeds the predetermined threshold. In the preferred embodiment, field scaling is performed when the ratio exceeds 1.5. In comparison to the odd field scaling, however, even field scaling has additional boundary problems. For example, because the even field is displaced in the video source by one line, the even field must be displaced or offset by one line in relation to the odd field when displayed. This offset is accomplished by the insertion of an additional boundary line into line 0 (or, if the scale ratio is extremely large, lines 0-n, where n is a

number larger than 0). The boundary lines can be derived from any of a number of sources. For example, in the preferred embodiment, the boundary line is black. In other embodiments, the boundary line is derived from the Windows 95 background. In still other embodiments, the boundary line is derived from line 0 of the other frame.

Continuing to refer to FIG. 6B, once the boundary line has been determined, line 0 of the even field is mapped directly to the next scaled field line. When the boundary is only one scan line wide, as shown in FIG. 6B, line 0 of the even field is mapped directly to Line 1 of the scaled field. The graphics controller then interpolates Line 2 of the scaled field, based on the values of line 0 and line 1 of the even field. Then, line 3 of the scaled field is mapped from line 1 of the even field. In this manner, the larger scaled field is determined from the even field, without reference to any value of the odd field (except perhaps at the boundary). Only the scan lines of the even field and the values interpolated therebetween determine the scaled field lines. Generally, all of the even field lines and none of the odd field lines are used, and are mapped directly to particular lines of the scaled field, and additional scaled lines are thus determined by interpolation. It will also be apparent that any of a variety of interpolation schemes can be used. Although not shown, horizontal enlargement or shrinking of the image may be accomplished simultaneously.

It is important to recognize that only one of the methods described with reference to FIGS. 6A and 6B (that is, either the method of FIG. 6A or the method of FIG. 6B) is performed at any one time. There is no attempt to enmesh the two fields together.

Referring now to FIG. 7, one method according to one embodiment of the present invention is shown. At step 702, an input video field in YUV space is received at a video port to the VGA subsystem. At step 704, the video port provides an interrupt IRQ signal and a video signal. At step 706, the IRQ signal is interpreted by a VxD, indicating that a video field has been received at the video port and also indicates the field type, i.e., whether the field is an odd field or an even field. At step 708, the video port also provides a video signal directly to the VGA Controller. At step 710, the VxD identifies the arrival or end of a received video field to the VPM driver, and sets a register in the graphics controller corresponding to where to store the data corresponding to the video field. The VxD also identifies whether the input video signal received by the video port at that moment is an even field or an odd field and provides the identification to the VPM driver.

The VxD receives the addresses of the appropriate buffer from the VPM driver. At step 720, the VxD counts the number of consecutive fields of each type. The VxD also maintains a threshold value, a value that may be programmable. Different embodiments have different thresholds; in one embodiment, the threshold is 60 fields consecutive of the same type, either odd or even. At step 722, a comparison is made between the count of the number of consecutive fields of the present type, and the threshold. If the threshold is exceeded, for example if the number of consecutive fields of the present type is greater than 60, then at step 724 the VGA subsystem enters OneField Mode. If the field is of a different type from the preceding field, or if the number of consecutive fields of the present type is less than the threshold, at step 726 the VGA subsystem enters or remains in FieldScale Mode.

Many video sources have occasional glitches in which several fields of either odd or even type are provided

consecutively. For example, if a television show breaks for or returns from a commercial, several fields of the same type may be provided consecutively. Therefore, a threshold is used to determine whether the video source is truly a single-type source, such as a video game, or a mere glitch that should not be the basis for a mode transition.

At step 726, when the VGA subsystem is in FieldScale mode, the VPM Driver commands "flipping" from one buffer to another when the IRQ signal is received. The pointer indicating the location in memory for storing the next field is flipped between the frontbuffer and the backbuffer when a new field is received by the input port, at the time the IRQ is generated. At steps 727 and 728, the data corresponding to the field is placed in a buffer or buffers. In the OneField mode either odd or even fields are directed to either buffer. At step 728, which is performed when the VGA subsystem is in FieldScale Mode, the data corresponding to the field is placed in the single buffer corresponding to the field type. Specifically, if the field is an odd field, then the field data are placed in the odd buffer. If the field is an even field, then the field data are placed in the even buffer. In this manner, in the FieldScale mode, received fields are placed alternately in the odd and even buffers. Therefore, all the odd fields are placed in one buffer and all the even fields are placed in the other buffer.

At step 730, the Graphics Controller receives the data from the buffers and determines the mode of the VGA subsystem. At step 731, the VPM Driver calls DirectDraw (initiating the DirectDraw Driver) in order to indicate which buffer to display, and where it should be displayed, and passes to DirectDraw the addresses of the buffer or buffers in the MDRAM 350 where the field data is stored. The output of the VPM Driver is provided to the DirectDraw Driver, which provides a signal to the VGA Controller. The DirectDraw Driver is used to make the graphics controller present data from the two buffers alternately on the display. There is no meshing of the images from one buffer with the images from the other buffer, except in the eye of the person viewing the image. Each field is scaled as described below in reference to FIGS. 6A and 6B.

At steps 732 and 734, the DirectDraw Driver causes the Graphics Controller to display the fields in an appropriate manner, and mixes video field data with graphics information for display. At step 732, the buffers are shown on the display without offset. Step 732 is performed when the VGA subsystem is in OneField mode. At step 734, the display of one of the fields has an offset of one scan line with respect to the other field. Step 734 is performed by the DirectDraw driver when the VGA subsystem is in FieldScale mode.

Because data from one field only is presented at any given moment in time, temporal data from different points in time are not mixed. Each field is received individually, and is displayed individually. As with standard video, motion is achieved in the eye of the viewer. The interpolation of the missing scan lines provided in the FieldScale algorithm of FIGS. 6A and 6B provide almost as good a resolution as would copying the missing scan lines from the alternate field, and eliminates the temporal artifacts of blurring and double imaging caused by mixing temporal data. Also, because the alternate field is flipped onto the field of view only  $\frac{1}{60}$ th of a second later, the human eye provides a mixing of the interpolated scan line with the true data in the alternate field, substantially correcting for any loss of resolution.

In addition to a home theater system, the present invention extends to other appliances. An appliance in the context of

the present invention refers to an electric device having processor intelligence, a display screen, and a video card, wherein video data is displayed for information or entertainment purposes.

The foregoing disclosure and description of the invention are illustrative and explanatory thereof, and various changes in the details of the illustrated apparatus and construction and method of operation may be made without departing from the spirit of the invention.

What is claimed is:

1. A computer system having a processor, a video signal processing device coupled to the processor, and a video display device coupled to the video signal processing device, the video signal processing device coupled to receive at least two sequences of interlaced video fields each containing a set of data representing a plurality of scan lines, the video signal processing device for generating a second sequence of video frames and for providing the second sequence to the video display device, the video signal processing device comprising:

a first buffer and a next buffer, the first buffer coupled to receive data from a video frame input source when the first buffer does not contain valid data and from the next buffer when an output frame is provided by video display device, the next buffer coupled to receive data from a video frame input source when the first buffer contains data;

a compensator, coupled to receive data from the first buffer, the compensator being configured to compensate the data in the first buffer and further being coupled to provide a compensated field;

a graphics deinterlacer, coupled to receive the compensated field from the compensator and further coupled to receive data from the next buffer, the graphics deinterlacer being configured to deinterlace the data from the next buffer with the compensated field and to merge the data from the next buffer and the compensated field into a video frame of the second sequence; and

a graphics output coupled to receive the video frame of the second sequence from the deinterlacer and further coupled to provide the video frame of the second sequence to the video display device.

2. The computer system of claim 1, further comprising a removably insertable video card, the video signal processing device residing on the video card.

3. The computer system of claim 1, wherein the compensator further includes an offset shifter configured to provide a compensated field that is shifted with respect to data in the first buffer.

4. The computer system of claim 3, wherein the offset shifter is configured to provide a compensated field shifted vertically with respect to the data in the first buffer.

5. The computer system of claim 4, wherein the offset shifter is configured to provide a compensated field shifted vertically, with respect to the data in the first buffer, by a distance equal to the distance between adjacent scan lines.

6. The computer system of claim 1, wherein the compensator further includes a temporal offset shifter configured to provide a compensated field that is delayed with respect to data in the first buffer.

7. The computer system of claim 1, further including a field scale compensator, the field scale compensator coupled to receive the video frame of the second sequence from the graphics deinterlacer and to provide the video frame of the second sequence to the video display device, the field scale compensator being configured according to a particular

video display device and a particular video signal processing device to remove scan lines or to insert interpolated scan lines into each video frame of the second sequence.

8. The computer system of claim 7, wherein the field scale compensator includes a scan line counter, a mapping table, and an interpolator, wherein:

the scan line counter is configured to count the number of scan lines in each of the merged frame and the video display device and to determine a ratio of the number of scan lines;

the mapping table is coupled to receive the video frame of the second sequence from the graphics deinterlacer, the video frame having scan line indexed by number, the mapping table being indexed by scan line number and by the ratio, the mapping table reassigning scan line numbers to the scan lines of the video frame, the mapping table eliminating some of the scan lines if the ratio indicates the merged frame has more scan lines than the video display device, the mapping table providing a mapped frame; and

the interpolator is coupled to receive the mapped frame and is further enabled by a signal indicating whether the number of scan lines of the video display device is greater than of the merged frame, the interpolator being configured to determine values for scan lines of the video display device not mapped to by the mapping table, by interpolating between the scan lines of the that are mapped to by the mapping table, the interpolator providing a video frame to the video display device.

9. A video signal processing device having an input and an output, the input configured to receive at least two sequences of interlaced video fields each containing a set of data representing a plurality of scan lines from a computer system having a processor, the output configured to provide a second sequence of video frames to a video display device, the video signal processing device comprising:

a first buffer and a next buffer, the first buffer coupled to receive data from a video frame input source when the first buffer does not contain valid data and from the next buffer when an output frame is provided by a video display device, the next buffer coupled to receive data from a graphics input source when the first buffer contains data;

a compensator, coupled to receive data from the first buffer, the compensator being configured to compensate the data in the first buffer and further being coupled to provide a compensated field;

a graphics deinterlacer, coupled to receive the compensated field from the compensator and further coupled to receive data from the next buffer, the graphics deinterlacer being configured to deinterlace the data from the next buffer with the compensated field and to merge the data from the next buffer and the compensated field into a video frame of the second sequence; and

a graphics output coupled to receive the video frame of the second sequence from the deinterlacer and further coupled to provide the video frame of the second sequence to the video display device.

10. The video signal processing device of claim 9, further configured as a video card removably insertable into the computer system.

11. The video signal processing device of claim 9, wherein the compensator further includes an offset shifter configured to provide a compensated field that is shifted with respect to data in the first buffer.

12. The video signal processing device of claim 11, wherein the offset shifter is configured to provide a com-

## 15

compensated field shifted vertically with respect to the data in the first buffer.

13. The video signal processing device of claim 12, wherein the offset shifter is configured to provide a compensated field shifted vertically, with respect to the data in the first buffer, by a distance equal to the distance between adjacent scan lines.

14. The computer system of claim 9, wherein the compensator further includes a temporal offset shifter configured to provide a compensated field that is delayed with respect to data in the first buffer.

15. The video signal processing device of claim 9, further including a field scale compensator, the field scale compensator coupled to receive the video frame of the second sequence from the graphics deinterlacer and to provide the video frame of the second sequence to the video display device, the field scale compensator being configured according to a particular video display device and a particular video signal processing device to remove scan lines or to insert interpolated scan lines into each video frame of the second sequence.

16. The video signal processing device of claim 15, wherein the field scale compensator includes a scan line counter, a mapping table, and an interpolator, wherein:

the scan line counter is configured to count the number of scan lines in each of the merged frame and the video display device and to determine a ratio of the number of scan lines;

the mapping table is coupled to receive the video frame of the second sequence from the graphics deinterlacer, the video frame having scan line indexed by number, the mapping table being indexed by scan line number and by the ratio, the mapping table reassigning scan line numbers to the scan lines of the video frame, the mapping table eliminating some of the scan lines if the ratio indicates the merged frame has more scan lines than the video display device, the mapping table providing a mapped frame; and

the interpolator is coupled to receive the mapped frame and is further enabled by a signal indicating whether the number of scan lines of the video display device is greater than of the merged frame, the interpolator being configured to determine values for scan lines of the video display device not mapped to by the mapping table, by interpolating between the scan lines of the that are mapped to by the mapping table, the interpolator providing a video frame to the video display device.

17. In a video signal processing system receiving at least two sequences of interlaced video fields each containing a set of data representing a plurality of scan lines, a method of generating a second sequence of video frames, the method comprising the steps of:

receiving a first video field;  
temporarily storing the first video field in an input buffer;  
and

in a loop, while video fields are being received, performing the steps of:

receiving a next video field;  
compensating the video field in the input buffer;  
deinterlacing the received video field with the compensated field in the input buffer;

storing the received next video field in the input buffer;  
merging the received field and the compensated field into a video frame of the second sequence; and

providing the video frame of the second sequence to a video display device, wherein the step of receiving the

## 16

next field includes a step of reading data from one of a plurality of buffers, each buffer being read in turn.

18. In a video signal processing system receiving at least two sequences of interlaced video fields each containing a set of data representing a plurality of scan lines, a method of generating a second sequence of video frames, the method comprising the steps of:

receiving a first video field;  
temporarily storing the first video field in an input buffer;  
and

in a loop, while video fields are being received, performing the steps of:

receiving a next video field;  
compensating the video field in the input buffer;  
deinterlacing the received video field with the compensated field in the input buffer;

storing the received next video field in the input buffer;  
merging the received field and the compensated field into a video frame of the second sequence; and

providing the video frame of the second sequence to a video display device, wherein the step of compensating includes a step of vertically offsetting a group of fields with respect to another group of fields.

19. The method of claim 18, wherein the step of vertically offsetting includes a step of vertically offsetting alternately read fields.

20. The method of claim 18, wherein the step of vertically offsetting includes a step of vertically offsetting by a distance equal to the distance between adjacent scan lines.

21. In a video signal processing system receiving at least two sequences of interlaced video fields each containing a set of data representing a plurality of scan lines, a method of generating a second sequence of video frames, the method comprising the steps of:

receiving a first video field;  
temporarily storing the first video field in an input buffer;  
and

in a loop, while video fields are being received, performing the steps of:

receiving a next video field;  
compensating the video field in the input buffer;  
deinterlacing the received video field with the compensated field in the input buffer;

storing the received next video field in the input buffer;  
merging the received field and the compensated field into a video frame of the second sequence; and

providing the video frame of the second sequence to a video display device, wherein the video display device has a number of scan lines different from the number of scan lines collectively represented in the merged fields, and the step of providing further includes a step of field scaling the merged frame.

22. The method of claim 21, wherein the step of field scaling includes steps of:

determining a number equal to the fewer of the number of scan lines in the merged frame and the number of scan lines in the video display device;

determining a first set of scan lines of the merged frame and a second set of scan lines of the video display device, the first set and the second set having a number of scan lines equal to the determined number;

mapping the first set into the second set.

23. The method of claim 22, wherein the number of scan lines of the video display device is greater than of the

merged frame, the method further including a step of determining values for scan lines of the video display device not in the second set by interpolating between the scan lines of the second set.

24. The method of claim 23, wherein the step of determining values for the scan lines includes steps of:

- calculating, for each scan line of the video display device not in the second set, a distance to the nearest video display device scan line in the second set;
- calculating, for each scan line of the video display device not in the second set, the distance between the two adjacent scan lines of the second set between which the scan line of the video display device not in the second set is located;
- calculating, for each scan line of the video display device not in the second set, a difference between the mathematical values of corresponding points among the two adjacent scan lines of the second set between which the scan line of the video display device not in the second set is located; and
- multiplying a ratio of the distances by the difference and adding the result of the multiplying to one of the adjacent lines within the second set.

25. In a video signal processing system receiving at least one sequences of interlaced video fields each containing a set of data representing a plurality of scan lines, a method of generating a second sequence of video frames, the method comprising the steps of:

- determining the number of sequences of interlaced video fields is being received by graphics subsystem;
- if the number of sequences of interlaced video fields is greater than one, performing the steps of:
  - receiving a first video field;
  - temporarily storing the first video field in an input buffer; and
  - in a loop, while video fields are being received, performing the steps of:
    - receiving a next video field;
    - compensating the video field in the input buffer;
    - deinterlacing the received video field with the compensated field in the input buffer;
    - storing the received next video field in the input buffer;
    - merging the received field and the compensated field into a video frame of the second sequence; and
    - providing the video frame of the second sequence to a video display device; and
  - if the number of sequences of interlaced video fields is exactly one, then performing in a loop, while video fields are being received, the steps of:
    - receiving a next field;
    - compensating the next field;
    - for two sync pulses, providing the video frame of the second sequence to a video display device.

26. An integrated home entertainment appliance containing a computer system and a television system, the appliance having a processor, a video signal processing device coupled to the processor, and a video display device coupled to the video signal processing device, the video signal processing device coupled to receive at least two sequences of interlaced video fields each containing a set of data representing a plurality of scan lines, the video signal processing device for generating a second sequence of video frames and for providing the second sequence to the video display device, the video signal processing device comprising:

- a first buffer and a next buffer, the first buffer coupled to receive data from a video frame input source when the

first buffer does not contain valid data and from the next buffer when an output frame is provided by video display device, the next buffer coupled to receive data from a video frame input source when the first buffer contains data;

- a compensator, coupled to receive data from the first buffer, the compensator being configured to compensate the data in the first buffer and further being coupled to provide a compensated field;
- a graphics deinterlacer, coupled to receive the compensated field from the compensator and further coupled to receive data from the next buffer, the graphics deinterlacer being configured to deinterlace the data from the next buffer with the compensated field and to merge the data from the next buffer and the compensated field into a video frame of the second sequence; and
- a graphics output coupled to receive the video frame of the second sequence from the deinterlacer and further coupled to provide the video frame of the second sequence to the video display device.

27. The home entertainment appliance of claim 26, further comprising a removably insertable video card, the video signal processing device residing on the video card.

28. The home entertainment appliance of claim 26, wherein the compensator further includes an offset shifter configured to provide a compensated field that is shifted with respect to data in the first buffer.

29. The home entertainment appliance of claim 28, wherein the offset shifter is configured to provide a compensated field shifted vertically with respect to the data in the first buffer.

30. The home entertainment appliance of claim 29, wherein the offset shifter is configured to provide a compensated field shifted vertically, with respect to the data in the first buffer, by a distance equal to the distance between adjacent scan lines.

31. The home entertainment appliance of claim 26, wherein the compensator further includes a temporal offset shifter configured to provide a compensated field that is delayed with respect to data in the first buffer.

32. The home entertainment appliance of claim 26, further including a field scale compensator, the field scale compensator coupled to receive the video frame of the second sequence from the graphics deinterlacer and to provide the video frame of the second sequence to the video display device, the field scale compensator being configured according to a particular video display device and a particular video signal processing device to remove scan lines or to insert interpolated scan lines into each video frame of the second sequence.

33. The home entertainment appliance of claim 32, wherein the field scale compensator includes a scan line counter, a mapping table, and an interpolator, wherein:

- the scan line counter is configured to count the number of scan lines in each of the merged frame and the video display device and to determine a ratio of the number of scan lines;

- the mapping table is coupled to receive the video frame of the second sequence from the graphics deinterlacer, the video frame having scan line indexed by number, the mapping table being indexed by scan line number and by the ratio, the mapping table reassigning scan line numbers to the scan lines of the video frame, the mapping table eliminating some of the scan lines if the ratio indicates the merged frame has more scan lines than the video display device, the mapping table providing a mapped frame; and

the interpolator is coupled to receive the mapped frame and is further enabled by a signal indicating whether the number of scan lines of the video display device is greater than of the merged frame, the interpolator being configured to determine values for scan lines of the video display device not mapped to by the mapping table, by interpolating between the scan lines of the that are mapped to by the mapping table, the interpolator providing a video frame to the video display device.

34. A computer system having a processing means, a video signal processing means coupled to the processing means, and a means for displaying video images coupled to the video signal processing means, the video signal processing means coupled to receive at least two sequences of interlaced video fields each containing a set of data representing a plurality of scan lines, the video signal processing means for generating a second sequence of video frames and for providing the second sequence to the video display means, the video signal processing means comprising:

a first means for receiving and storing data and a next means for receiving and storing data, wherein the first means for receiving and storing data being coupled to receive data from a video frame input source when the first means for receiving and storing data does not contain valid data and from the next means for receiving and storing data when an output frame is provided by the video display means, the data in the first means forming a first field, and the next means for receiving and storing data is coupled to receive data from a video frame input source when the first means for receiving and storing data contains data, the data in the next means forming a next field;

a compensating means, coupled to receive data from the first field, the compensating means being configured to compensate the data in the first means for receiving and storing data and further being coupled to provide a compensated field;

a means for deinterlacing two video fields into a video frame, the deinterlacing means coupled to receive the compensated field and also coupled to receive the next field, the deinterlacing means being configured to deinterlace the next field with the compensated field and to merge the next field and the compensated field into a video frame of the second sequence; and

means for providing an output, said output coupled to receive the video frame of the second sequence from the deinterlacing means and further coupled to provide the video frame of the second sequence to the video display means.

35. A video signal processing means having an input and an output, the input configured to receive at least two sequences of interlaced video fields each containing a set of data representing a plurality of scan lines from a computer system having a processing means, the output configured to provide a second sequence of video frames to a means for displaying video images, the video signal processing means comprising:

a first means for receiving and storing data and a next means for receiving and storing data, wherein the first means for receiving and storing data is coupled to receive data from a video frame input source when the first means for receiving and storing data does not contain valid data and from the next means for receiving and storing data when an output frame is provided by the video display means, the data in the first means forming a first field, and

the next means for receiving and storing data is coupled to receive data from a graphics input source when the first means for receiving and storing data contains data, the data in the next means forming a next field;

a compensating means, coupled to receive data from the first field, the compensating means being configured to compensate the data in the first means for receiving and storing data and further being coupled to provide a compensated field;

a means for deinterlacing two video fields into a video frame, said deinterlacing means coupled to receive the compensated field and also coupled to receive the next field, the deinterlacing means being configured to deinterlace the next field with the compensated field and to merge the next field and the compensated field into a video frame of the second sequence; and

means for providing an output, said output coupled to receive the video frame of the second sequence from the deinterlacing means and further coupled to provide the video frame of the second sequence to the video display means.

36. An integrated home entertainment appliance containing a computer system and a television system, the appliance having a processing means, a video signal processing means coupled to the processing means, and a means for displaying video images coupled to the video signal processing means, the video signal processing means coupled to receive at least two sequences of interlaced video fields each containing a set of data representing a plurality of scan lines, the video signal processing means for generating a second sequence of video frames and for providing the second sequence to the video display means, the video signal processing means comprising:

a first means for receiving and storing data and a next means for receiving and storing data, wherein the first means for receiving and storing data is coupled to receive data from a video frame input source when the first means for receiving and storing data does not contain valid data and from the next means for receiving and storing data when an output frame is provided by the video display means, the data in the first means forming a first field, and

the next means for receiving and storing data is coupled to receive data from a video frame input source when the first means for receiving and storing data contains data, the data in the next means forming a next field;

a compensating means, coupled to receive data from the first field, the compensating means being configured to compensate the data in the first means for receiving and storing data and further being coupled to provide a compensated field;

a means for deinterlacing two video fields into a video frame, said deinterlacing means coupled to receive the compensated field and also coupled to receive the next field, the deinterlacing means being configured to deinterlace the next field with the compensated field and to merge the next field and the compensated field into a video frame of the second sequence; and

means for providing an output, said output coupled to receive the video frame of the second sequence from the deinterlacing means and further coupled to provide the video frame of the second sequence to the video display means.

37. The integrated home entertainment appliance of claim 36, further comprising a means for determining the number

## 21

of sequences of interlaced video fields is being received by the video signal processing means, wherein the first means and the deinterlacing means are enabled by the signal, the video signal processing means further comprising:

a hold-and-repeat buffering means, disabled by the signal, 5  
that for two sync pulses, provides the video frame of the second sequence to a video display device.

38. In an integrated home entertainment appliance, a video signal processing means having at least a first input, a second input and an output, the first input configured to receive at least two sequences of interlaced video fields each containing a set of data representing a plurality of scan lines from a computer system having a processing means, the second input configured to receive at least two sequences of interlaced video fields each containing a set of data representing a plurality of scan lines from a television source, the output configured to provide a second sequence of video frames to a means for displaying video images, the video signal processing means comprising:

a first means for receiving and storing data and a next 20  
means for receiving and storing data, wherein the first means for receiving and storing data being coupled to receive data from a video frame input source when the first means for receiving and storing data does not contain valid data and from the next 25  
means for receiving and storing data when an output

## 22

frame is provided by the video display means, the data in the first means forming a first field, and the next means for receiving and storing data is coupled to receive data from a graphics input source when the first means for receiving and storing data contains data, the data in the next means forming a next field;

a compensating means, coupled to receive data from the first field, the compensating means being configured to compensate the data in the first means for receiving and storing data and further being coupled to provide a compensated field;

a means for deinterlacing two video fields into a video frame, said deinterlacing means coupled to receive the compensated field and also coupled to receive the next field, the deinterlacing means being configured to deinterlace the next field with the compensated field and to merge the next field and the compensated field into a video frame of the second sequence; and

means for providing an output, said output coupled to receive the video frame of the second sequence from the deinterlacing means and further coupled to provide the video frame of the second sequence to the video display means.

\* \* \* \* \*